

hot & cold - Brushed stainless steel / platinum matt













ST 050 521 8985



- max. flow 81.5 l/min at 3 bar flow pressure
- PEARLSTREAM
- rain shower with anti-scale system
- suitable for xGRID (when using installation track + 12 mm recess depth)
- concealed rough parts
- exposed trim parts
- temperature setting via thermostat
- overhead shower: rain flow

Individual components of this set

You need the following components for this set

	1x	35 085 970 90		2x	35 206 970 90
	1x	35 521 970 90		1x	35 531 970 90
	1x	12 360 970 90		2x	12 370 970 90
	1x	13 425 979-06		1x	27 838 979-06
	2x	36 517 979-06		1x	28 775 980-06
	1x	36 503 985-06		3x	36 607 985-06
	2x	36 607 985-06			



hot & cold - Brushed stainless steel / platinum matt

ST 050 521 8985

hot & cold - Brushed stainless steel / platinum matt

ST 050 521 8985



- red brass, lead-free
- female thread 1/2" connection
- 1x female thread 1/2" outlet
- dust cover
- anti-water packing
- soundproofing

For wall-mounted spouts and wall outlet elbows with 1/2" connection.

Recommended miscellaneous

Leak protection 1/2" -

12 010 970 90



hot & cold - Brushed stainless steel / platinum matt

ST 050 521 8985

mm [inches]

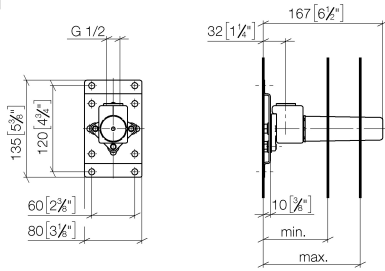

	min	max
CL_1	90 [3 1/2"]	163 [6 3/8"]
CL_2	68 [2 5/8"]	135 [5 3/8"]
Domicil	90 [3 1/2"]	163 [6 3/8"]
Gentle	90 [3 1/2"]	163 [6 3/8"]
IMO	90 [3 1/2"]	163 [6 3/8"]
Lissé	90 [3 1/2"]	163 [6 3/8"]
MEM	90 [3 1/2"]	163 [6 3/8"]
Symetrics	90 [3 1/2"]	163 [6 3/8"]
Vaia	90 [3 1/2"]	163 [6 3/8"]

Certificates

WRAS_1904021. LGA_29336.

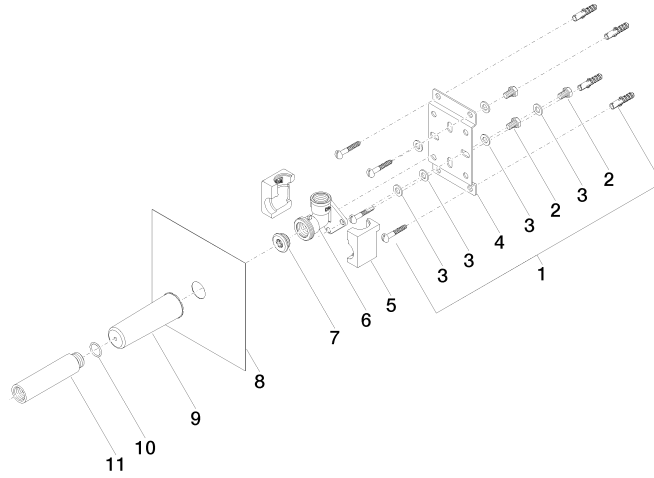

Spare parts list

No.	Item Number	Name	Quantity used	Delivery time
1	04 30 31 024 01 90	fixing set	2	2
2	09 30 30 152 90	screw	3	2
3	09 30 11 139 90	disc	6	2
4	09 17 20 094 90	holder	1	2
5	09 11 11 036 90	accessories	1	2
6	09 11 03 041 10 90	connection	1	2
7	04 31 20 006 00 90	plug	1	2
8	04 14 03 072 01 90	gasket kit	1	2
9	09 21 02 102 90	cap	1	2
10	90 14 10 010 00 90	seal	1	2
11	09 24 03 169 10 90	adaptor	1	2

hot & cold - Brushed stainless steel / platinum matt

ST 050 521 8985

- female thread 1/2" connection
- dust cover
- anti-water packing



Recommended miscellaneous

Leak protection 1/2" -

12 010 970 90



Recommended miscellaneous

**xGRID Attachment set for
integrating in the dry wall
construction -**

12 340 970 90



Required miscellaneous

xGRID Installation track 555 mm - 12 360 970 90





hot & cold - Brushed stainless steel / platinum matt

ST 050 521 8985

hot & cold - Brushed stainless steel / platinum matt

ST 050 521 8985

mm [inches]

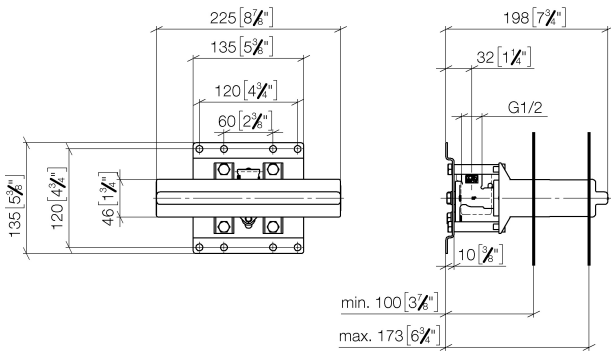

Certificates

WRAS_2106011. LGA_19489.

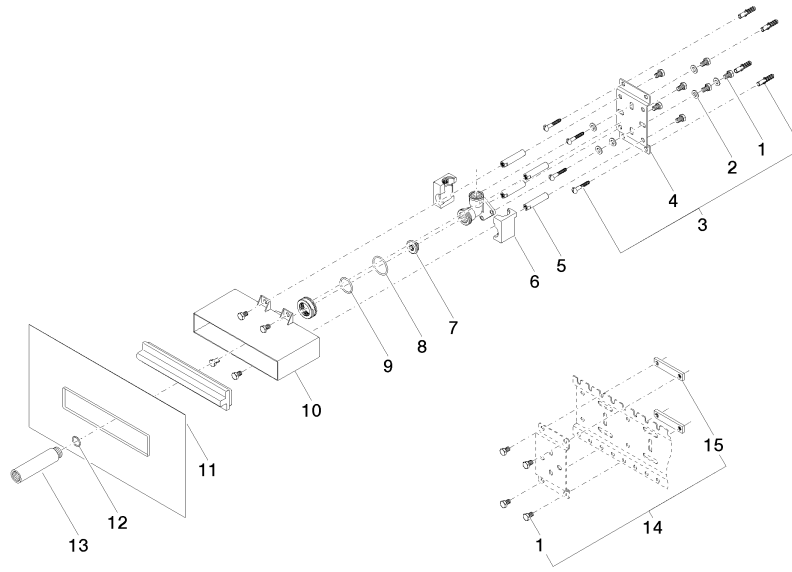

Spare parts list

No.	Item Number	Name	Quantity used	Delivery time
1	09 30 30 152 90	screw	15	2
2	09 30 11 139 90	disc	6	2
3	04 30 31 024 01 90	fixing set	2	2
4	09 17 20 094 90	holder	1	2
5	09 18 40 138 90	sleeve	1	60
6	09 11 11 036 90	accessories	1	2
7	04 31 20 006 00 90	plug	1	2
8	09 14 10 149 90	seal	1	2
9	09 14 10 118 90	seal	1	2
10	09 11 11 053 90	accessories	1	60
11	04 14 03 126 00 90	gasket kit	1	2
12	90 14 10 010 00 90	seal	1	2
13	09 24 03 169 10 90	adaptor	1	2
14	04 17 20 100 00 90	fixing set	1	2
15	09 17 20 100 90	holder	2	2

hot & cold - Brushed stainless steel / platinum matt

ST 050 521 8985



- red brass, lead-free
- 2x back flow preventer
- 2x female thread 3/4" connections
- 1x female thread 3/4" outlet for additional valves
- 2x female thread 3/4" outlet, right/left alternatively
- 3x dust cover
- 3x anti-water packing
- soundproofing
- gauge 120 mm
- suitable for xGRID (when using installation track + 12 mm recess depth)

Recommended miscellaneous

Extension 28 mm -

12 177 970 90



Recommended miscellaneous

Extension 46 mm -

12 178 970 90



Recommended miscellaneous

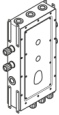

Drybox Thermostat module with 2 valves - 39 521 970 90

- Overflow is part of the scope of delivery.

Recommended miscellaneous



xGRID Attachment set for integrating in the dry wall construction -

12 340 970 90

Required miscellaneous

xGRID Installation track 555 mm - 12 360 970 90





hot & cold - Brushed stainless steel / platinum matt

ST 050 521 8985

hot & cold - Brushed stainless steel / platinum matt

ST 050 521 8985

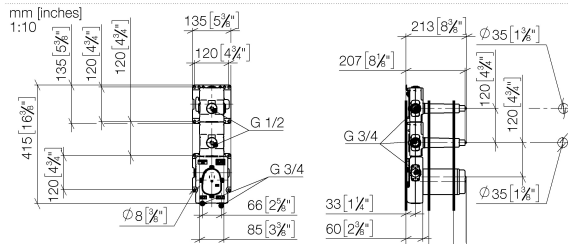

Art Nr.	Serie	min	max
36xxx361-FF	Madison	85 [3 3/8"]	110 [4 3/8"]
36xxx371-FF	Madison	85 [3 3/8"]	110 [4 3/8"]
36xxx710-FF	LULU	85 [3 3/8"]	110 [4 3/8"]
36xxx809-FF	VAIA	85 [3 3/8"]	110 [4 3/8"]
36xxx819-FF	VAIA	85 [3 3/8"]	110 [4 3/8"]
36xxx882-FF	Tara	95 [3 3/4"]	160 [6 1/4"]
36xxx892-FF	Tara	95 [3 3/4"]	160 [6 1/4"]
36xxx811-FF	CYO	95 [3 3/4"]	160 [6 1/4"]
36xxx812-FF	CYO	95 [3 3/4"]	160 [6 1/4"]
36xxx740-FF	Meta/CL.1/ CYO	95 [3 3/4"]	160 [6 1/4"]
36xxx980-FF	Symetrics	95 [3 3/4"]	160 [6 1/4"]
36xxx985-FF	Symetrics	95 [3 3/4"]	160 [6 1/4"]
36xxx705-FF	CL.1	115 [4 1/2"]	155 [6 1/8"]
36xxx715-FF	CL.1	115 [4 1/2"]	155 [6 1/8"]
36xxx782-FF	MEM	115 [4 1/2"]	155 [6 1/8"]

Certificates

Belgaqua_21-031- WRAS_2011026. ACS_21 ACC LY 141. DVGW_DW-27_6. 6512DN0706.

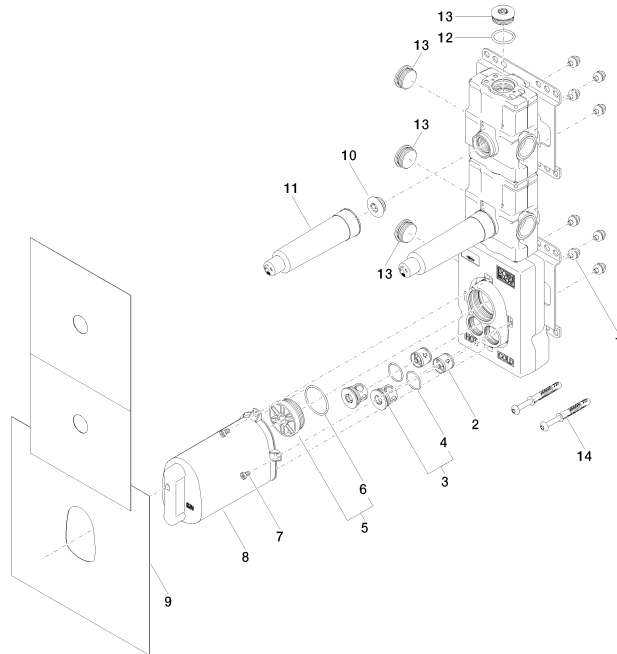

Spare parts list

No.	Item Number	Name	Quantity used	Delivery time
1	90 23 01 091 00 90	set	8	2
2	90 23 01 045 00 90	back-flow preventer	2	2
3	04 21 34 077 00 90	nipple	2	2
4	09 14 10 098 90	seal	2	2
5	04 31 20 100 00 90	plug	1	2
6	09 14 10 111 90	seal	1	2
7	09 30 30 112 90	screw	4	2
8	04 21 02 174 01 90	cap	1	2
9	04 14 03 073 06 90	gasket kit	1	2
10	04 31 20 006 00 90	plug	2	2
11	09 21 02 173 90	cap	2	2
12	09 14 10 009 90	seal	1	2
13	09 31 20 003 90	plug	4	2
14	04 30 31 054 00 90	fixing set	2	2

hot & cold - Brushed stainless steel / platinum matt

ST 050 521 8985



- red brass, lead-free
- 2x back flow preventer
- 2x female thread 3/4" connections
- 1x female thread 3/4" outlet for additional valves
- 3x female thread 3/4" outlet, right/left alternatively
- 4x dust cover
- 4x anti-water packing
- soundproofing
- gauge 120 mm
- suitable for xGRID (when using installation track + 12 mm recess depth)

Recommended miscellaneous

Extension 28 mm -

12 177 970 90



Recommended miscellaneous

Extension 46 mm -

12 178 970 90



Recommended miscellaneous

Drybox Thermostat module with 3 valves - 39 531 970 90



Recommended miscellaneous

xGRID Attachment set for integrating in the dry wall construction - 12 340 970 90



Required miscellaneous

xGRID Installation track 555 mm - 12 360 970 90





hot & cold - Brushed stainless steel / platinum matt

ST 050 521 8985

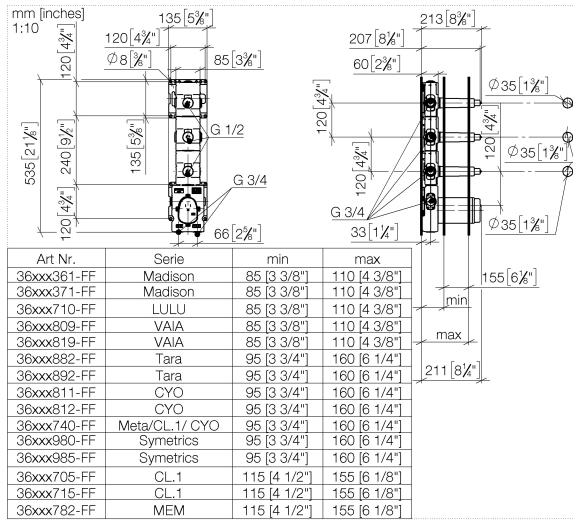

Certificates

Belgaqua_21-031- WRAS_2011026. ACS_21 ACC LY 141. DVGW_DW-21-031-6512DN0706.

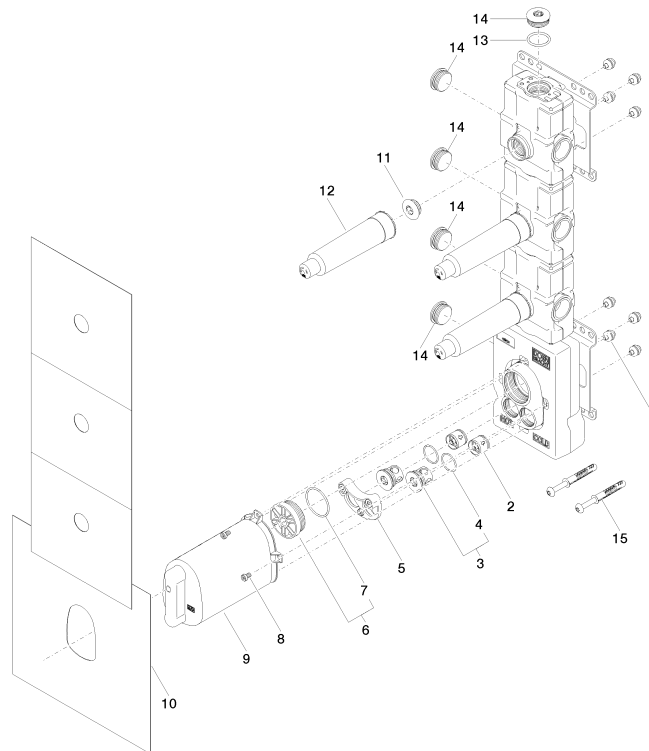

Spare parts list

No.	Item Number	Name	Quantity used	Delivery time
1	90 23 01 091 00 90	set	8	2
2	90 23 01 045 00 90	back-flow preventer	2	2
3	04 21 34 077 00 90	nipple	2	2
4	09 14 10 098 90	seal	2	2
5	90 12 12 218 00 90	base	1	2
6	04 31 20 100 00 90	plug	1	2
7	09 14 10 111 90	seal	1	2
8	09 30 30 112 90	screw	4	2
9	04 21 02 174 01 90	cap	1	2
10	04 14 03 073 07 90	gasket kit	1	2
11	04 31 20 006 00 90	plug	3	2
12	09 21 02 173 90	cap	3	2
13	09 14 10 009 90	seal	1	2
14	09 31 20 003 90	plug	5	2
15	04 30 31 054 00 90	fixing set	2	2

hot & cold - Brushed stainless steel / platinum matt

ST 050 521 8985

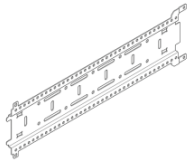

- width 555mm
- height 135 mm
- depth 12 mm
- retaining screws and plugs

More about the xGRID installation track can be found in the Shower Book brochure



hot & cold - Brushed stainless steel / platinum matt

ST 050 521 8985

hot & cold - Brushed stainless steel / platinum matt

ST 050 521 8985

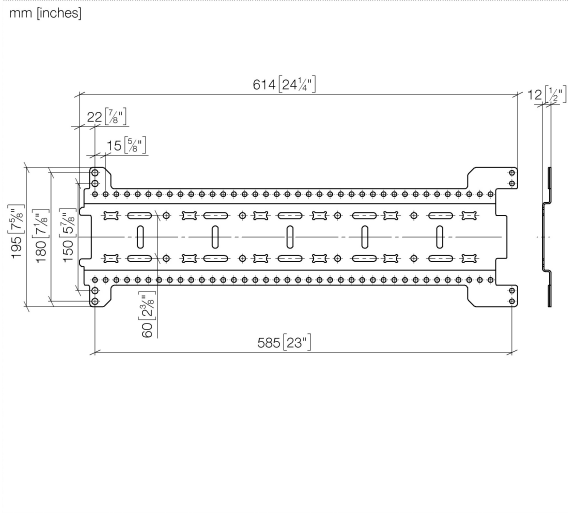

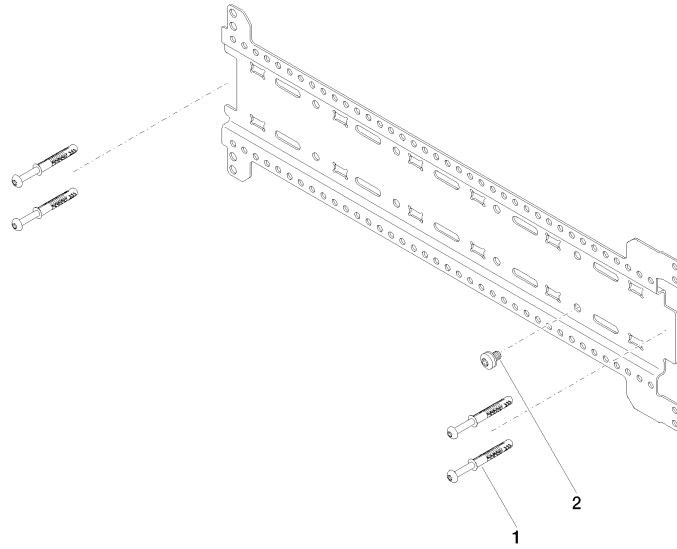

Spare parts list

No.	Item Number	Name	Quantity used	Delivery time
1	04 30 31 054 00 90	fixing set	2	2
2	04 30 30 212 00 90	fixing set	1	60

hot & cold - Brushed stainless steel / platinum matt

ST 050 521 8985

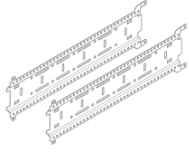

- width 555mm
- height 135 mm
- depth 12 mm
- retaining screws and plugs

This set contains 2 xGRID installation tracks and includes fixing material

More about the xGRID installation track can be found in the Shower Book brochure



hot & cold - Brushed stainless steel / platinum matt

ST 050 521 8985

hot & cold - Brushed stainless steel / platinum matt

ST 050 521 8985

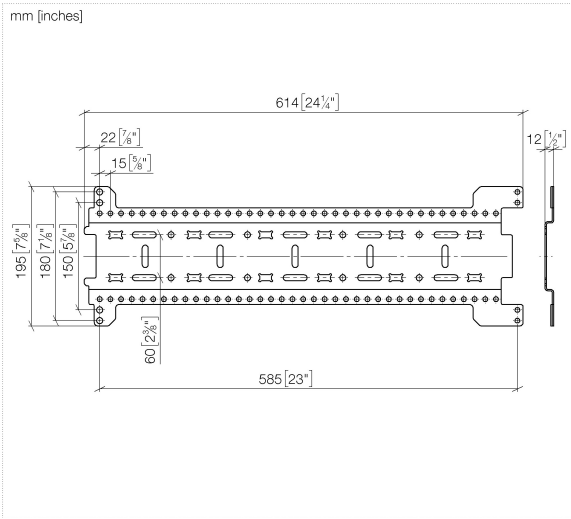

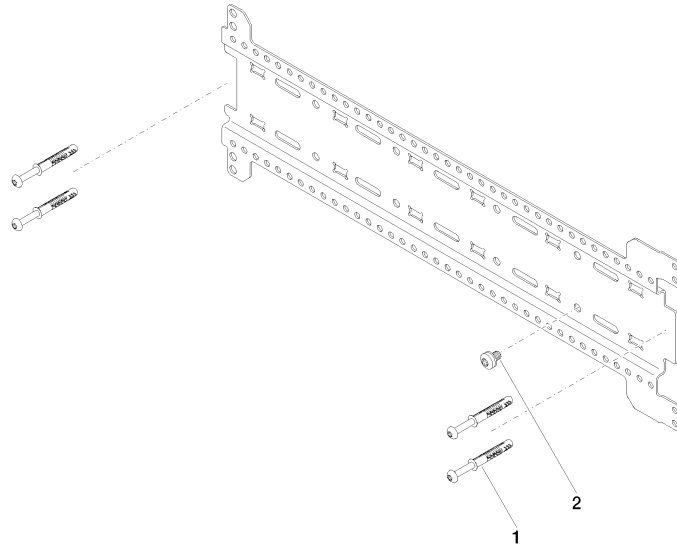

Spare parts list

No.	Item Number	Name	Quantity used	Delivery time
1	04 30 31 054 00 90	fixing set	4	2
2	04 30 30 212 00 90	fixing set	2	60











hot & cold - Brushed stainless steel / platinum matt

ST 050 521 8985



- 22mm projection
- PEARLSTREAM
- plate 240 mm x 60 mm
- connection 1/2", for shortening
- plug-link mounting
- Max. flow rate 9.5 l/min (at 3 bar)

Fits: IMO, LULU, MADISON, MEM, TARA, CL.1, LISSÉ, VAIA, META, CYO

	Brushed Platinum	13 425 979-06
	Chrome	13 425 979-00
	Platinum	13 425 979-08
	Dark Chrome	13 425 979-19
	Light Gold	13 425 979-26
	Brushed Light Gold	13 425 979-27
	Brushed Durabross (23kt Gold)	13 425 979-28
	Matte Black	13 425 979-33
	Brushed Bronze	13 425 979-42
	Brushed Champagne (22kt Gold)	13 425 979-46
	Champagne (22kt Gold)	13 425 979-47
	Brushed Chrome	13 425 979-93
	Brushed Dark Platinum	13 425 979-99

Recommended miscellaneous



- Concealed wall elbow -**
- max. recess depth 163 mm
 - min. recess depth 90 mm

35 085 970 90

Recommended miscellaneous



- Concealed wall elbow -**
- max. recess depth 163 mm
 - min. recess depth 90 mm

35 085 970 90



hot & cold - Brushed stainless steel / platinum matt

ST 050 521 8985

hot & cold - Brushed stainless steel / platinum matt

ST 050 521 8985

mm [inches]

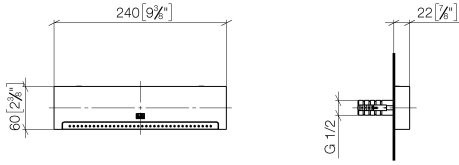

Flow rate chart

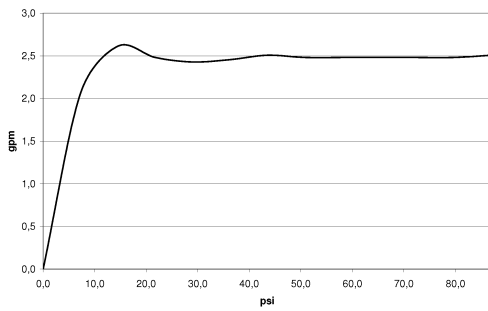

Certificates

LGA_19935.

IAPMO_4976 (6).

Trajectory diagram

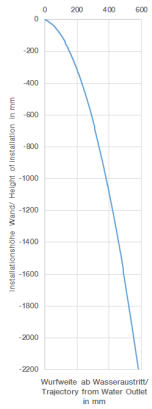

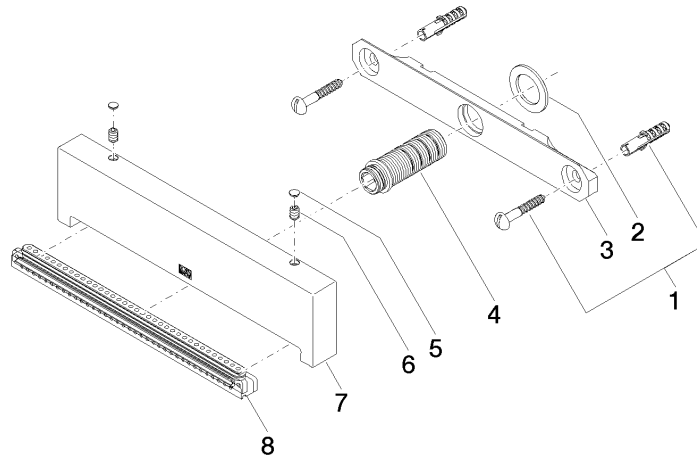

Spare parts list

No.	Item Number	Name	Quantity used	Delivery time
1	04 30 31 024 01 90	fixing set	1	2
2	09 14 05 009 90	seal	1	2
3	09 17 97 053 90	holder	1	2
4	90 24 03 199 00 90	connection	1	2
5	90 31 20 087 00-06	plug	1	10
6	09 31 11 144 90	pin	2	2
8	90 29 03 071 00 90	insert	1	2

hot & cold - Brushed stainless steel / platinum matt









ST 050 521 8985



Fits: IMO, MEM, CL.1, CYO

- LAMINAR FLOW, max. flow rate 15 l/min (at 3 bar)
- 3/8" shower outlet
- cover plate 240 x 60 mm
- metal shower hose 1250mm with integrated anti-twist protection
- 1/2" connection
- plug-link mounting

Intrinsic protection against back flow.

	Brushed Platinum	27 838 979-06
	Chrome	27 838 979-00
	Platinum	27 838 979-08
	Dark Chrome	27 838 979-19
	Brushed Durabronze (23kt Gold)	27 838 979-28
	Matte Black	27 838 979-33
	Brushed Chrome	27 838 979-93
	Brushed Dark Platinum	27 838 979-99

Recommended miscellaneous



Concealed wall elbow -

- max. recess depth 163 mm
- min. recess depth 90 mm

35 085 970 90



hot & cold - Brushed stainless steel / platinum matt

ST 050 521 8985

hot & cold - Brushed stainless steel / platinum matt

ST 050 521 8985

mm [inches]

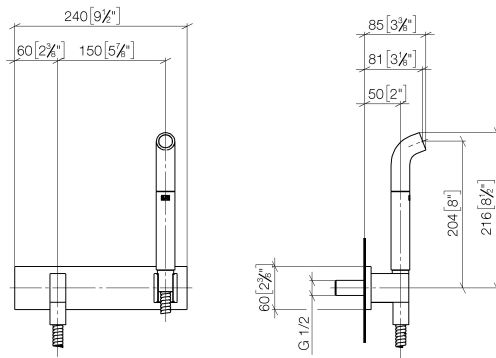

Flow rate chart

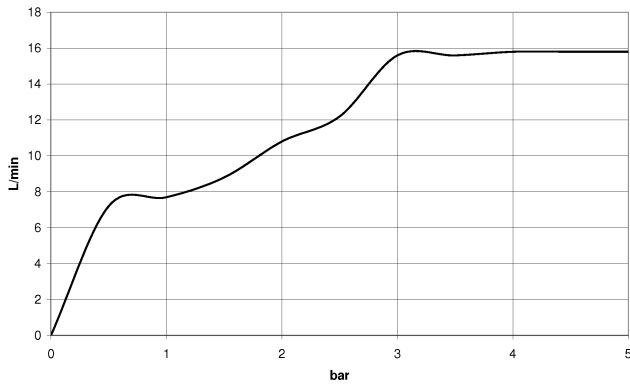

Certificates

Belgaqua_21-023- LGA_38675.
27_8.

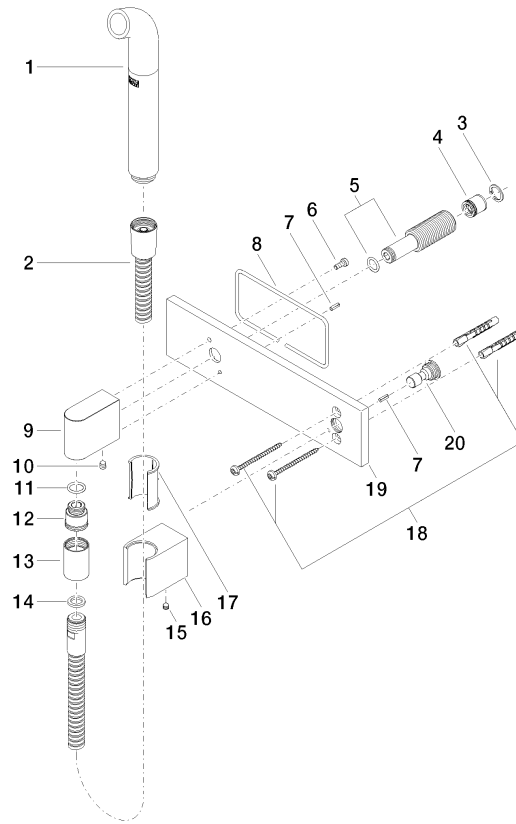

Spare parts list

No.	Item Number	Name	Quantity used	Delivery time
1	04 12 11 073 01-06	spout	1	10
2	90 30 02 072 00-06	Metal shower hose 1/2" x 3/8" x 1250 mm - Brushed Platinum	1	10
3	09 16 01 014 90	ring	1	2
4	09 23 01 046 90	back-flow preventer	1	2
5	90 24 03 212 00 90	nipple	1	2
6	09 14 10 008 90	seal	1	2
7	09 31 11 026 90	pin	2	2
8	09 14 03 127 90	seal	1	2
9	09 11 03 046-06	connection	1	10
10	90 31 11 004 00 90	pin	1	2
11	90 14 10 077 00 90	seal	1	2
12	09 24 03 107 20 90	nipple	1	2
13	90 21 02 069 00-06	cover	1	10
14	90 14 20 026 00 90	seal	1	2
15	90 31 11 112 00 90	pin	1	2
16	09 17 20 044-06	holder	1	10
17	09 18 40 078 90	sleeve	1	2
18	05 30 31 025 00 90	fixing set	1	2
19	09 11 02 133-06	plate	1	10
20	09 24 03 073 90	nipple	1	2





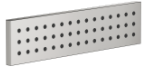







hot & cold - Brushed stainless steel / platinum matt

ST 050 521 8985



- HORIZONTAL RAIN, max. flow rate 6 l/min (at 3 bar)
- with anti-scale system
- cover plate 240 x 60 mm
- 1/2" connection
- This product can help a building meet the requirements of Green Building Rating Systems, e.g. LEED®, BREEAM®, DGNB

Fits: IMO, LULU, MADISON, MEM, TARA, CL.1, LISSÉ, VAIA, META, CYO

	Brushed Platinum	36 517 979-06
	Chrome	36 517 979-00
	Platinum	36 517 979-08
	Dark Chrome	36 517 979-19
	Light Gold	36 517 979-26
	Brushed Light Gold	36 517 979-27
	Brushed Durabross (23kt Gold)	36 517 979-28
	Matte Black	36 517 979-33
	Brushed Bronze	36 517 979-42
	Brushed Champagne (22kt Gold)	36 517 979-46
	Champagne (22kt Gold)	36 517 979-47
	Brushed Chrome	36 517 979-93
	Brushed Dark Platinum	36 517 979-99

Required miscellaneous



- Concealed wall installation box - 35 206 970 90**
- max. recess depth 173 mm
 - min. recess depth 100 mm

Recommended miscellaneous



- xGRID Attachment set for integrating in the dry wall construction - 12 340 970 90**

Required miscellaneous



- xGRID Installation track 555 mm - 12 360 970 90**



hot & cold - Brushed stainless steel / platinum matt

ST 050 521 8985

hot & cold - Brushed stainless steel / platinum matt

ST 050 521 8985

mm [inches]

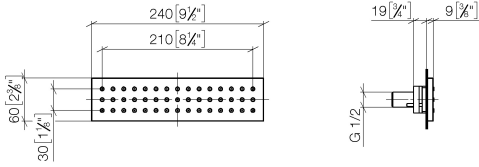

Flow rate chart

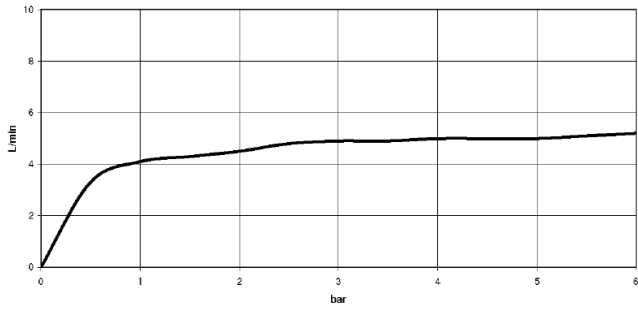

Certificates

WRAS_1304001. LGA_19489.

Trajectory diagram

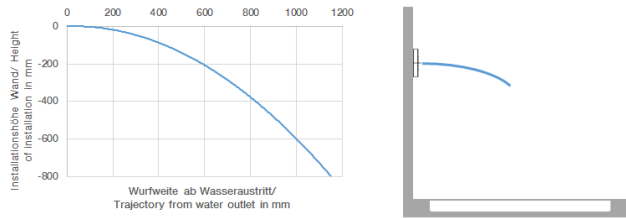

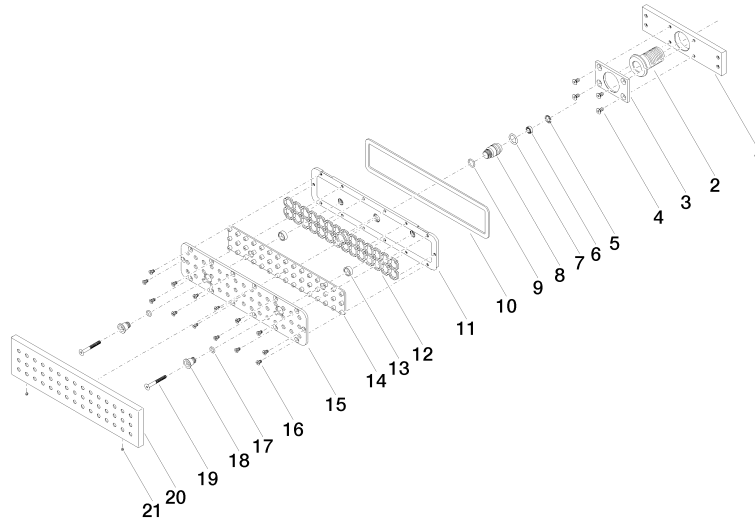

Spare parts list

No.	Item Number	Name	Quantity used	Delivery time
1	09 11 02 137 90	holder	1	2
2	09 24 04 247 20 90	connection	1	2
3	09 11 02 138 90	plate	1	2
4	09 30 30 116 90	screw	4	2
5	09 16 01 016 90	ring	1	2
6	90 23 01 032 00 90	flow reducer	1	2
7	09 14 10 003 90	seal	1	2
8	09 24 04 248 90	nipple	1	2
9	09 14 10 042 90	seal	1	2
10	09 14 03 133 90	seal	1	2
12	09 17 97 058 90	holder	1	2
13	09 28 10 142 20 90	ring	2	2
14	09 12 01 076 90	insert	1	60
15	09 11 02 136-00	cover	1	60
16	09 30 30 163 90	screw	14	2
17	09 14 10 132 90	seal	2	2
19	09 30 30 164 90	screw	2	2
20	09 27 99 001-06	rosette	1	10
21	09 31 11 006 90	pin	2	2

hot & cold - Brushed stainless steel / platinum matt







ST 050 521 8985



Fits: IMO, MEM, CL.1

- rain shower 300 x 240mm
- PURE RAIN, max. flow rate 20 l/min (at 3 bar)
- Function from: 12 l/min
- distance between ceiling and lower edge of the shower 165mm
- rosette 60 x 60, as required
- 1/2" connection
- with anti-scale system
- quick clearing
- WRAS 1707033

Product change as of 1st April 2024: max. flow 20l/min

	Brushed Platinum	28 775 980-06
	Chrome	28 775 980-00
	Platinum	28 775 980-08
	Dark Chrome	28 775 980-19
	Brushed Durabronze (23kt Gold)	28 775 980-28
	Matte Black	28 775 980-33
	Brushed Champagne (22kt Gold)	28 775 980-46
	Champagne (22kt Gold)	28 775 980-47
	Brushed Chrome	28 775 980-93
	Brushed Dark Platinum	28 775 980-99

Recommended miscellaneous



Concealed wall elbow -

- max. recess depth 163 mm
- min. recess depth 90 mm

35 085 970 90



hot & cold - Brushed stainless steel / platinum matt

ST 050 521 8985

hot & cold - Brushed stainless steel / platinum matt

ST 050 521 8985

mm [inches]

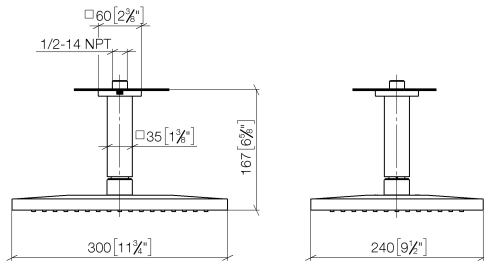

Flow rate chart

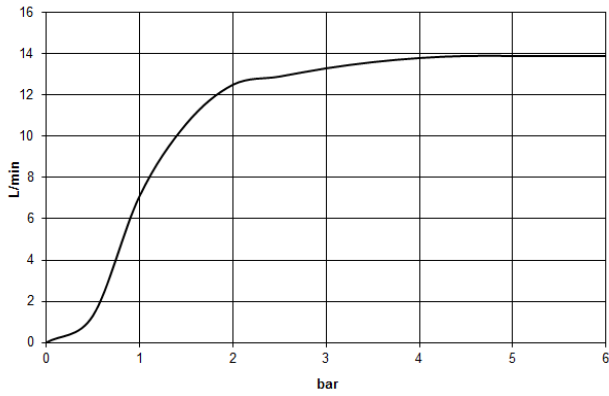

Certificates

LGA_29232.

WRAS_2212012.

LGA_38662.

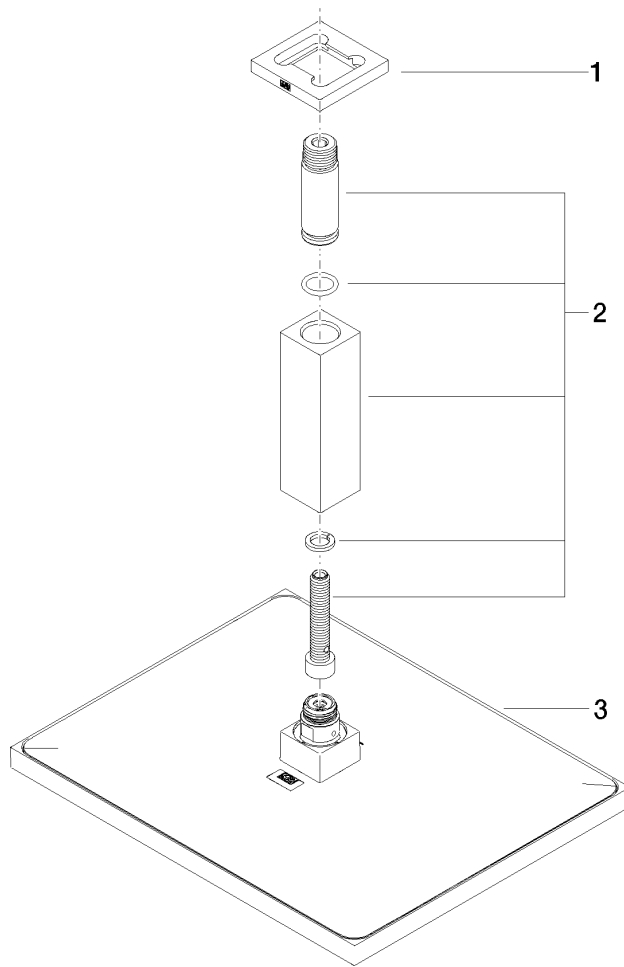

Spare parts list

No.	Item Number	Name	Quantity used	Delivery time
1	09 27 98 017-06	rosette	1	10
2	90 11 10 092 00-06	connection	1	10
3	04 12 05 063 00-06	shower	1	10

hot & cold - Brushed stainless steel / platinum matt

ST 050 521 8985



- cover plate 120 x 120 mm
- temperature control handle with safety limit stop at 38°C
- thermostat cartridge

Fits: IMO, MEM, CL.1, CYO

	Brushed Platinum	36 503 985-06
	Chrome	36 503 985-00
	Platinum	36 503 985-08
	Dark Chrome	36 503 985-19
	Brushed Durabronze (23kt Gold)	36 503 985-28
	Matte Black	36 503 985-33
	Brushed Champagne (22kt Gold)	36 503 985-46
	Champagne (22kt Gold)	36 503 985-47
	Brushed Chrome	36 503 985-93
	Brushed Dark Platinum	36 503 985-99

Required miscellaneous



xTOOL Concealed thermostat module without volume control - 35 503 970 90
 •max. recess depth 160 mm
 •min. recess depth 95 mm

Recommended miscellaneous



xGRID Attachment set for integrating in the dry wall construction - 12 340 970 90

Required miscellaneous



xGRID Installation track 555 mm - 12 360 970 90



hot & cold - Brushed stainless steel / platinum matt

ST 050 521 8985

hot & cold - Brushed stainless steel / platinum matt

ST 050 521 8985

mm [inches]

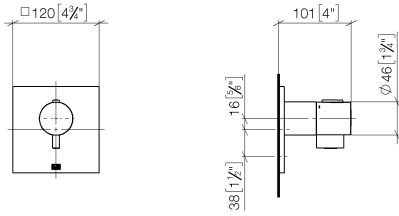

Flow rate chart

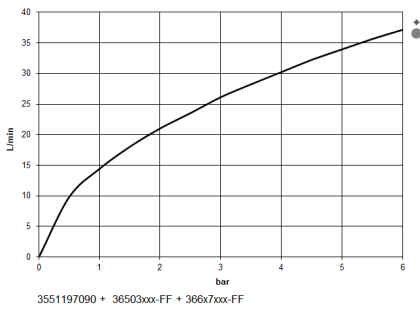

Certificates

WRAS_2011026.

DVGW_DW-
6512DN0706.

LGA_29930.

LGA_29932.

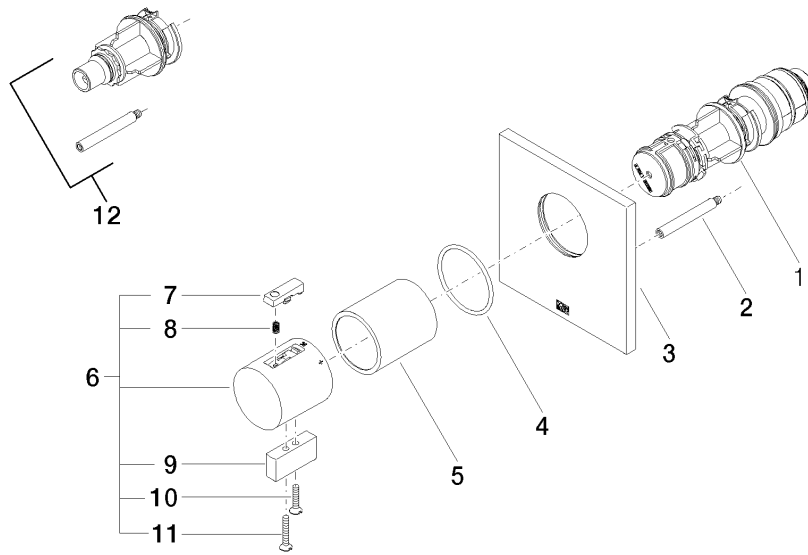

Spare parts list







No.	Item Number	Name	Quantity used	Delivery time
1	90 15 02 065 00 90	cartridge	1	2
2	90 31 09 095 00 90	bar	1	2
3	09 11 02 196-06	cover	1	60
4	90 14 10 049 00 90	seal	1	2
5	90 21 02 112 00-06	sleeve	1	10
6	04 17 33 006 00-06	handle	1	60
7	90 21 33 011 00-13	handle	1	2
8	90 16 02 027 00 90	spring	1	2
9	09 20 33 006-06	handle	1	10
10	09 30 30 159-06	screw	1	10
11	09 30 30 160-06	screw	1	10
12	12 178 970 90	Extension 46 mm -	1	2

hot & cold - Brushed stainless steel / platinum matt

ST 050 521 8985

- rosette 60 x 60 mm
- head part with cut-to-length spindle and sleeve



	Brushed Platinum	36 607 985-06
	Chrome	36 607 985-00
	Platinum	36 607 985-08
	Brushed Durabross (23kt Gold)	36 607 985-28
	Brushed Chrome	36 607 985-93
	Brushed Dark Platinum	36 607 985-99

Required miscellaneous



- Wall valve 1/2" -** 35 607 970 90
- max. recess depth 145 mm
 - min. recess depth 75 mm



hot & cold - Brushed stainless steel / platinum matt

ST 050 521 8985

hot & cold - Brushed stainless steel / platinum matt

ST 050 521 8985

mm [inches]

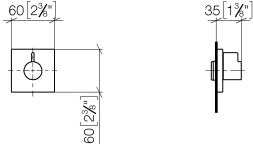

Certificates

DVGW_DW-
6501DN0116.

WRAS_2011026.

IAPMO_4976 (1).

LGA_29931.

WRAS_2010066.

DVGW_DW-
6512DN0706.

LGA_29932.

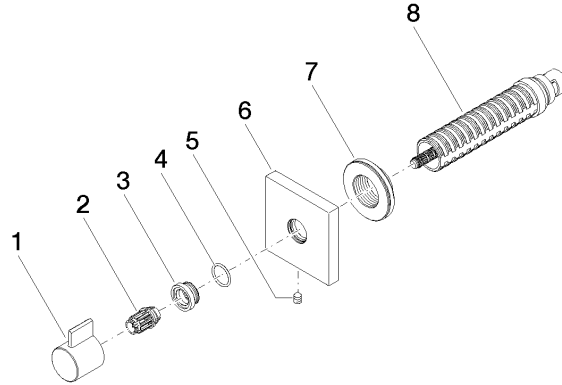

Spare parts list







No.	Item Number	Name	Quantity used	Delivery time
1	09 20 98 002-06	handle	1	10
2	09 12 12 005 90	fixing cap	1	2
3	09 12 12 043-06	base	1	10
4	09 14 10 017 90	seal	1	2
5	90 31 11 004 00 90	pin	1	2
6	09 27 98 014-06	rosette	1	10
7	09 21 02 151 90	sleeve	1	2
8	90 90 03 202 00 90	top	1	2

hot & cold - Brushed stainless steel / platinum matt

ST 050 521 8985

- rosette 60 x 60 mm
- head part with cut-to-length spindle and sleeve



	Brushed Platinum	36 607 985-06
	Chrome	36 607 985-00
	Platinum	36 607 985-08
	Brushed Durabress (23kt Gold)	36 607 985-28
	Brushed Chrome	36 607 985-93
	Brushed Dark Platinum	36 607 985-99

Required miscellaneous



- Wall valve 1/2" -** 35 607 970 90
- max. recess depth 145 mm
 - min. recess depth 75 mm



hot & cold - Brushed stainless steel / platinum matt

ST 050 521 8985

hot & cold - Brushed stainless steel / platinum matt

ST 050 521 8985

mm [inches]

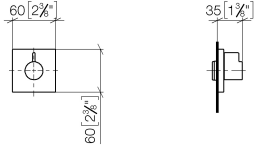

Certificates

DVGW_DW-
6501DN0116.

WRAS_2011026.

IAPMO_4976 (1).

LGA_29931.

WRAS_2010066.

DVGW_DW-
6512DN0706.

LGA_29932.

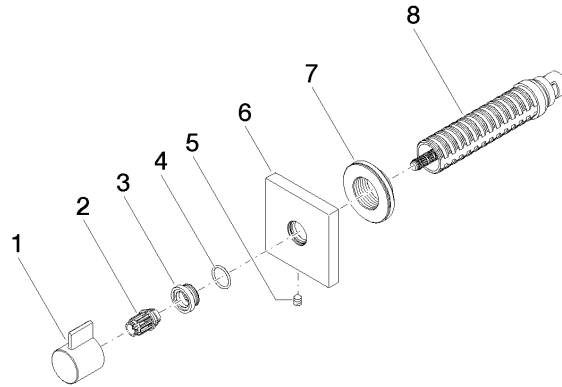

Spare parts list

No.	Item Number	Name	Quantity used	Delivery time
1	09 20 98 002-06	handle	1	10
2	09 12 12 005 90	fixing cap	1	2
3	09 12 12 043-06	base	1	10
4	09 14 10 017 90	seal	1	2
5	90 31 11 004 00 90	pin	1	2
6	09 27 98 014-06	rosette	1	10
7	09 21 02 151 90	sleeve	1	2
8	90 90 03 202 00 90	top	1	2